

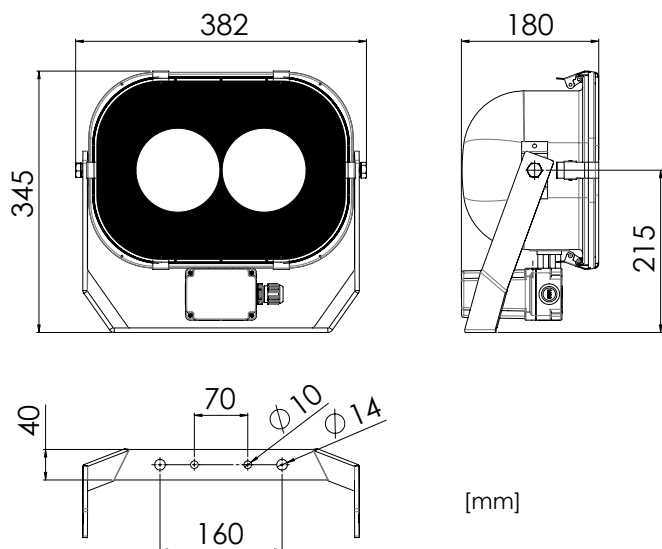







STAINLESS STEEL FLOODLIGHT FOR OPEN DECKS,
HOLDS AND HANGAR



STANDARD CONFIGURATION

Housing	Stainless steel, 1.4404 (AISI 316L), seamless deep drawn, powder coated white (RAL9016)
Safety pane	Tempered glass, DIN 12150, partially lacquered
Mounting	Stainless steel bracket, adjustable
Cable entry	Max. 2 cable glands
Protection class	IP67
Light source	2 × LED array
Wattage	2 × 25 W
Luminous flux	6,000 lm
CCT (color)	5,700 K
CRI	≥ 80

AVAILABLE FEATURES

	EMI proof
	Vibration resistant
	NVG compatible
	Adaptation light
	Multi-circuit
	Various optics

YOUR REQUIREMENTS

Please contact us for different configurations or further information on this luminaire type. Based on your requirements, the final part number will be provided.

Technical modification reserved without prior notice.



LIGHTPARTNER LICHTSYSTEME GMBH & CO. KG
AM MOHRENSHOF 7 · 28277 BREMEN · GERMANY
+49 (0)421 - 87 195 - 0 · SALES@LIGHTPARTNER.DE

LIGHTPARTNER NAVY